

# kWhCube

PANEL MOUNTING kWh METER

## OPERATING INSTRUCTIONS

July 2002

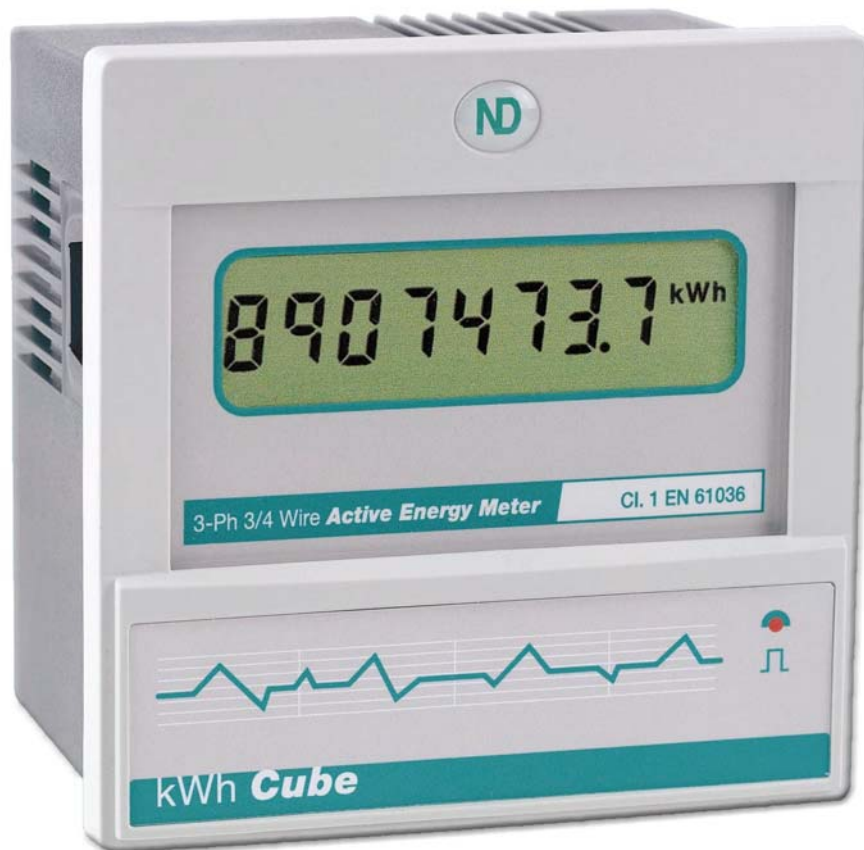

© Northern Design (Electronics) Ltd Bradford UK



# 1 Safety

This instruction sheet gives details of safe installation and operation of the **kWhCube** electricity meter. Safety may be impaired if the instructions are not followed. Labels on each meter give details of equipment ratings for safe operation. Take time to examine all labels before commencing installation. Safety symbols on the meter have specific meanings.



**CAUTION**  
REFER TO USER MANUAL

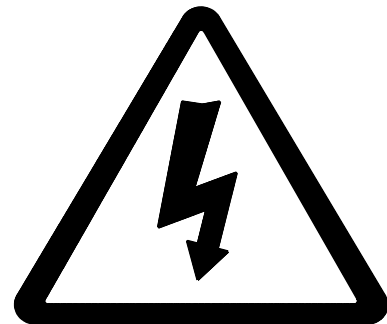

**WARNING**  
RISK OF  
ELECTRIC SHOCK

# 2 Cleaning

The front panel of the **kWhCube** may be cleaned by wiping lightly with a soft, clean cloth. No solvents or cleaning agents should be used.

### 3 Features

- **MEASUREMENT** - The standard *kWhCube* measures electrical energy (kWh) on single and/or three phase (3 or 4 wire) loads which may be balanced or unbalanced. Instantaneous kW is also available to aid commissioning.
- **LIQUID CRYSTAL DISPLAY** - The *kWhCube* provides kW / kWh readings on an 8-digit LCD with LED backlight. In the event of power failure to the meter, kWh readings are stored for 10 years (minimum).
- **CT and/or PT INPUTS** - Connection to the *kWhCube* is normally via Current and/or Potential Transformers. The meter is programmable to take into account scaling factors required to give direct readings of primary power and energy.
- **DISPLAY SCALING** - Displays are scaled conveniently to provide optimum resolution for the measured load. The display shows W, kW or MW with appropriate decimal points determined by the CT and/or PT programming.
- **PULSE OUTPUT** - The *kWhCube* may be **OPTIONALLY** fitted with one or two pulse outputs suitable for input to building management systems. The unit may be programmed, to provide a single pulse per 1, 10, 100 or 1000 increments of the LCD energy register. A solid state relay (SPNO) is used giving 100ms (optionally 500ms) pulses in the form of volt free 'contact closures'.

## 4 Mounting the Unit

Panels should be of thickness 1mm to 4mm with a square cut-out of 92mm (+0.8 - 0.0). A minimum depth of 72mm should be allowed behind the panel for the meter. Remove the panel mounting clips and insert the meter into the cut-out from the front of the panel. Push the meter home. Ensure the screws in each panel mount clip are fully retracted and insert the clips as shown in the diagram below. Tighten the screws to secure the meter firmly in the panel.

DO NOT OVERTIGHTEN.

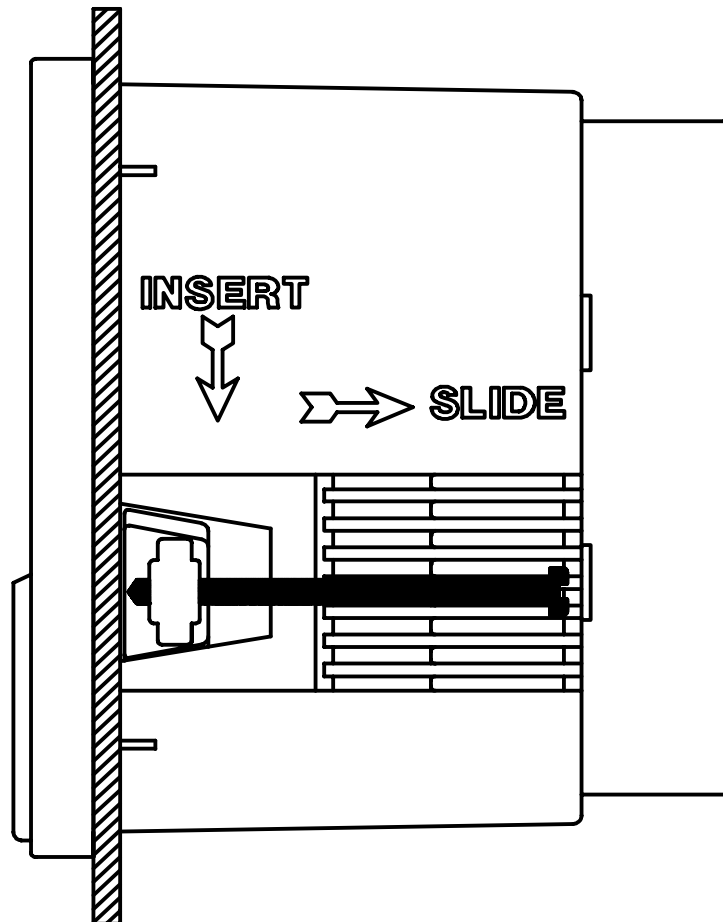

**Figure 1 Fitting The Meter in a Panel**

## 5 Current Inputs

Recommended external CTs should conform to Class 1 per IEC 60044-1. The secondary of the CT should be specified to suit the input rating defined on the meter label (5A as standard). Cables used for the current circuit should have a maximum conductor size of 4.0mm<sup>2</sup> and should be kept as short as possible to reduce cable losses loading the CT secondary.

### **WARNING**

**NEVER** allow the secondary of a current transformer to become open circuit while a primary current flows. Under these conditions dangerous voltages may be produced at the secondary terminals.

## 6 Voltage Inputs

Cables used for the voltage measurement circuit should have minimum ratings of 600V, 250mA AC. The maximum conductor size is 4.0mm<sup>2</sup>. External protection fuses are recommended for the voltage measurement inputs. These should be rated at 160mA max, Type F, with a voltage rating to suit the maximum inputs to the meter.

## 7 Auxiliary Mains Supply (L & N)

The *kWhCube* is supplied from an auxiliary mains input, isolated from all other inputs. This may be connected separately or in parallel with the measurement inputs. Ensure the ratings detailed on the instrument label are not exceeded. Separate connection of the auxiliary mains is advantageous when :

- Measurement voltages are expected to vary over a wide range
- Measurement voltages are unsuitable for meter supply
- Voltage inputs are taken from low power PT secondaries.

The auxiliary mains supply must be externally fused. An anti-surge (Type T) fuse should be used, rated 230V with a rupture current of 100 mA.

# 8 Meter Connections

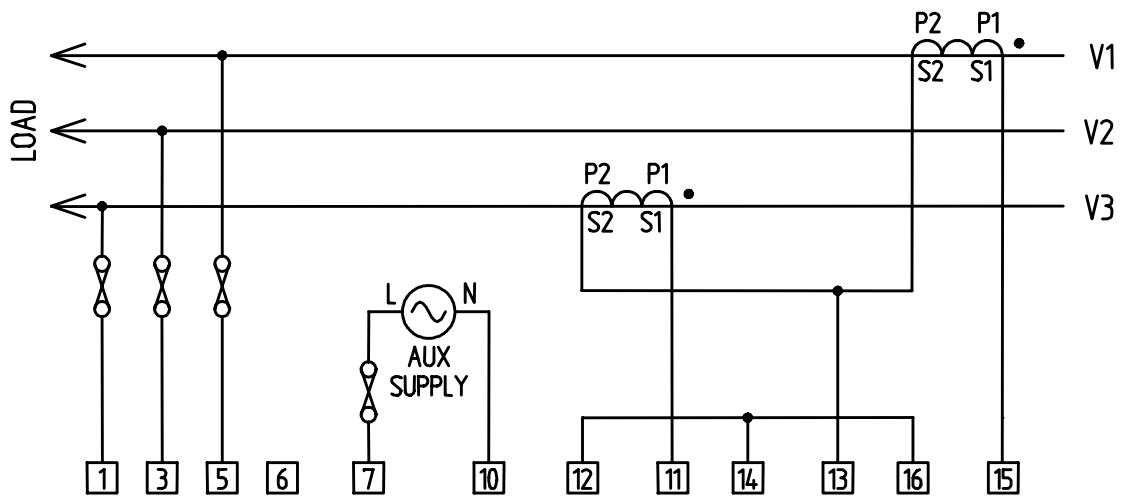

**Figure 2 3-Phase 3-Wire (2CTs)**

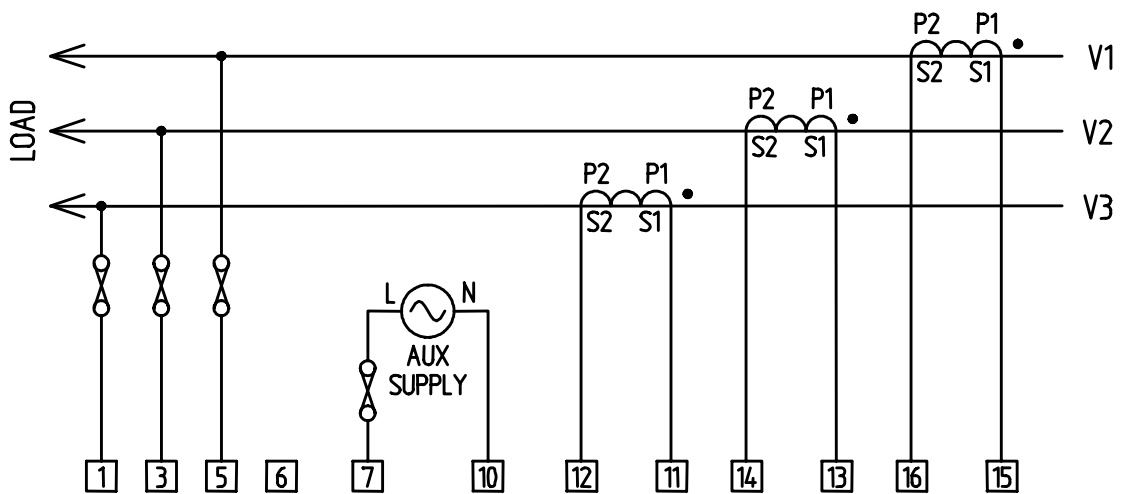

**Figure 3 3-Phase 3-Wire (3CTs)**

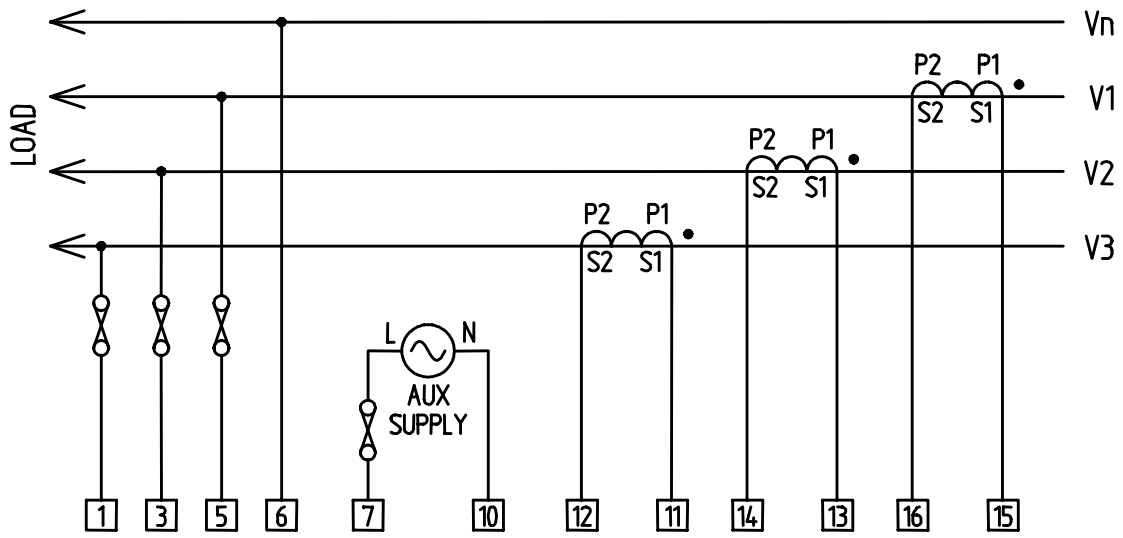

**Figure 4 3-Phase 4-Wire**

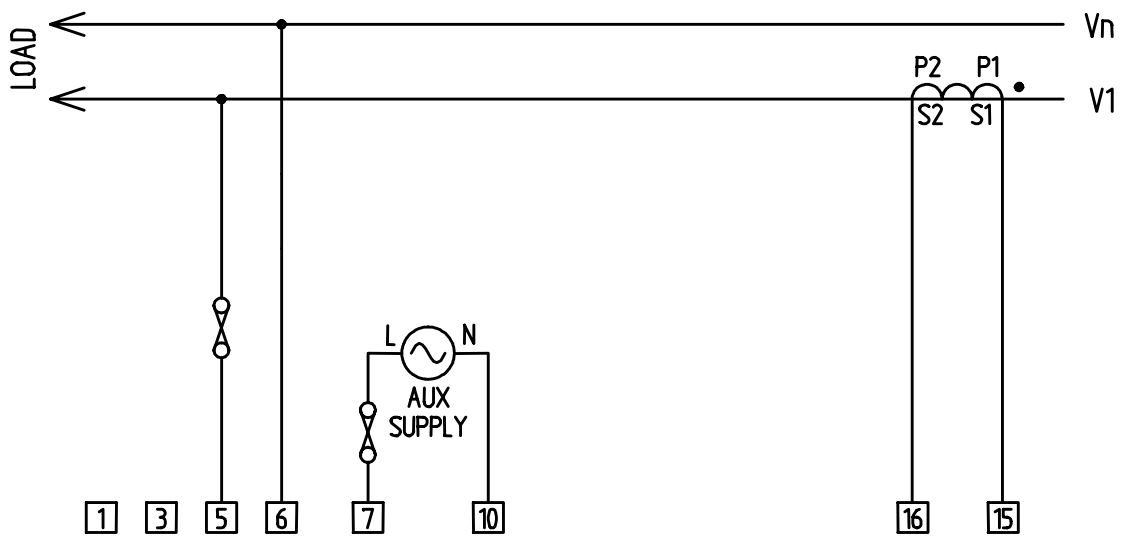

**Figure 5 Single Phase**

## 8.1 Optional Pulse Output(s)

An isolated pulse output (#1) may optionally be provided on the **kWhCube**. The pulse output provides a volt free contact pair closure for a programmable number of increments (1, 10, 100 or 1000) of the energy display. (e.g. 1 pulse per 10 kWh). The signal provided is designed to interface to building management systems, data collectors, remote counters etc.

On completion of the programmed number of counts the Pulse Output terminals momentarily appear short circuit. As standard the contact closure period is 100ms but a period of 500ms is available as a factory fitted option. At all other times the pins appear open circuit. The Pulse Output terminals are isolated (@ 2.5kV) from all other parts of the instrument providing safe connection to external systems.

Each pulse output is indicated on the front panel of the **kWhCube** by a single flash of the  LED.

A second pulse output (#2), which provides an identical signal to that described above, may optionally be provided. This is isolated (50V DC) from the first and may be used as an input to a supplementary external system.

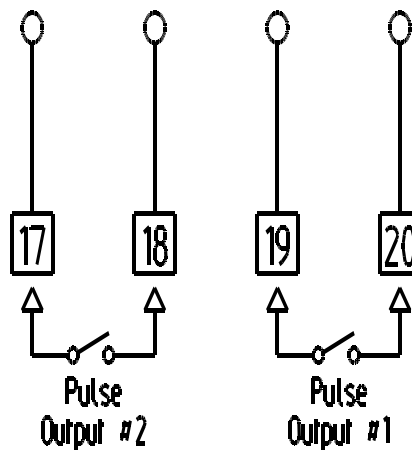

**Figure 6 Pulse Output Connection**

## 9 Operation

Three keys hidden behind the front panel are used during operation and commissioning to setup meter scaling and test the instantaneous measured load. The keys are accessible by pressing the areas highlighted below.

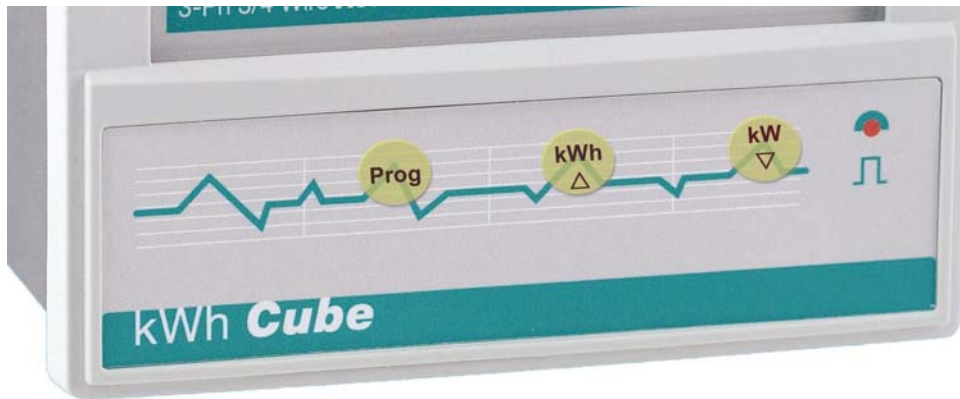

**Figure 7 Front Panel Hidden Keys**

### 9.1 Total kWh Register

This default display presented on power up shows total kWh on an 8-digit accumulating register. Register scaling is determined by user programmed CT and/or PT constants. On standard **kWhCube** meters this register may not be reset.

### 9.2 kWh Count Register

The kWh Count display is a 7-digit resetable accumulating energy register. This acts in a similar manner to the “Trip” display on a vehicle odometer.

- Press the **kWh** key to select Total kWh or kWh Count display pages. The kWh count display remains visible for 1 minute before the unit reverts to Total kWh mode.
- Press and hold the **kWh** and **Prog** keys for approximately 7 seconds to reset the kWh Count register to zero.

### 9.3 kW Display

A display of instantaneous kW is available by pressing the **kW** key. This display remains visible for 1 minute before the unit reverts to Total kWh mode. The kWh key may be used to return to kWh mode before the minute has elapsed.

## 9.4 Reverse Connections

If the **kWhCube** detects negative power at its input terminals the '**REV CT**' message is displayed and the kWh register is frozen.

This condition is most commonly caused by wiring errors. The most common of these errors is incorrect orientation of CT primaries (P1/P2) or secondaries (S1/S2).

## 10 Meter Constants

The **kWhCube** displays are scaled to take account of external current and/or voltage transformers. Two scaling factors **CT** and **SCAL** are provided for convenience. These are multiplied together to provide a single constant for the meter. Values of CT range from 10 to 2000 in steps of 10. SCAL may be set as 0.1, 1, 10, 100 or 1000.

### 10.1 CTs Only Fitted

In systems with no voltage transformers the **CT** constant should be equal to the primary rating of the CTs connected. The **SCAL** constant would normally be set to 1.0.

If non-standard CTs are fitted it is possible to combine the two constants (**CT** x **SCAL**) to achieve the desired result. For example if 25A CTs are used select **CT=250** and **SCAL=0.1**.

### 10.2 CTs and VTs Fitted

When current and voltage transformers are used **CT** and **SCAL** may be combined to provide a single constant as:

$$\mathbf{CT \times SCAL = CT \text{ Primary} \times PT \text{ Primary} / PT \text{ Secondary}}$$

For example if 500A CTs and 11000/110V VTs are used select **CT=500** and **SCAL=100**

## 10.3 Display Scaling

Display legends and a decimal point provide optimum resolution for any load as:

Nominal kW	Resolution	
< 2.88 kW	1 Wh	0.1 W
< 28.80 kW	0.01 kWh	0.001 kW
< 288.00 kW	0.1 kWh	0.01 kW
< 2.88 MW	1 kWh	0.1 kW
< 28.8 MW	0.01 MWh	0.001 MW
< 288 MW	0.1 MWh	0.01 MW
<2880 MW	1 MWh	0.1 MW

Where: **Nominal kW = 3 x Vnom x CT x SCAL**

**Vnom** is the nominal phase voltage measurement rating of the *KwhCube* detailed on the meter rating label.

## 11 Programming

To enter programming mode Press **PROG** and **hold** for 5 seconds. The unit shows the CT Primary Setup screen.

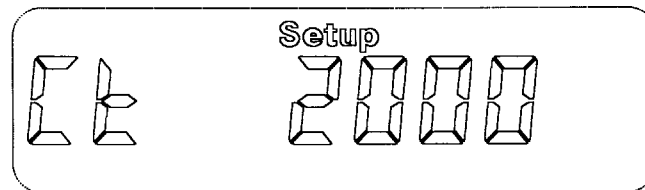

The CT primary rating may be adjusted in 10A steps by pressing the  $\Delta$  or  $\nabla$  keys until the desired current is displayed. Press **PROG** when the selection is complete.

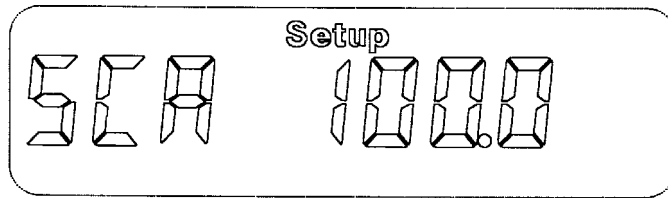

Press the  $\Delta$  or  $\nabla$  keys until the desired Scaling Factor is displayed. Press **PROG** when the selection is complete.

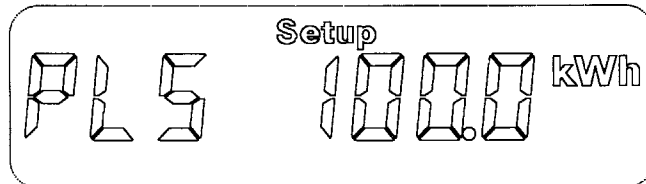

Pulse output is optional on the **KWhCube**. If no pulse output is fitted this setting has no effect on meter operation.

Pulse output rate may be set to provide 1 pulse after each 1, 10, 100 or 1000 increments of the LCD register. Press the  $\Delta$  or  $\nabla$  keys until the desired Pulse Rate is displayed. Press **PROG** when the selection is complete.

# 12 SPECIFICATION

<b>AUX MAINS</b>	Nominal 230V, $\pm 15\%$ , 45-65Hz Optional 110V Burden 3W max
<b>VOLTAGE</b>	Nominal Un = 400V L-L, 230V L-N Optional Un = 110V L-L, 63.5V L-N Other voltages available to special order AC 45-65Hz fundamental Range = Un $\pm$ 20% Burden 0.1W per phase Overload 2 x Un for 2 Seconds
<b>CURRENT</b>	Nominal Ib = 5A rms Optional Ib = 1A rms Range = 0.005 Ib to 1.2 Ib Burden 0.1VA per phase. Overload 40 x Ib for 1 Sec
<b>DISPLAY</b>	Liquid Crystal (LCD). 8 x 9mm Digits + Legends Backlight green LED Memory 10 Years in the event of power fail.
<b>PULSE*</b>	Normally Open Volt Free Contacts. Contact Rating 50V, 150mA, 5VA AC/DC. Standard 100mS Closure per display increment. Option 500ms Closure per display increment. Switching Time ( $t_r$ , $t_f$ ) 2mS max Contact Bounce 0.5mS max.
<b>STANDARDS</b>	Accuracy EN 61036 Class 1 (kWh) Safety EN 61010-1 (Installation category 3) EMC EN 50081-1 (Commercial Emissions) EN 50082-2 (Industrial Immunity)
<b>CASE</b>	DIN 96x96x80mm (72mm Behind panel) Mablex UL94-V-0 self-extinguishing Cut out 92mmx92mm (+0.8 -0.0) Panel 1mm to 4mm thick
<b>TERMINALS</b>	Rising Cage 0.25mm <sup>2</sup> to 4mm <sup>2</sup>
<b>OPERATION</b>	-10°C to 55°C. <75% RH non condensing
<b>STORAGE</b>	-25°C to 70°C. < 85% RH non condensing

\* Optional



Northern Design Design (Electronics) Ltd,  
228 Bolton Road, Bradford,  
West Yorkshire, BD3 0QW, England.  
Telephone: +44 (0) 1274 729533  
Fax: +44 (0) 1274 721074  
Email: [sales@ndmeter.co.uk](mailto:sales@ndmeter.co.uk)  
Or: [support@ndmeter.co.uk](mailto:support@ndmeter.co.uk)  
Copyright © Northern Design 2002

Mmm-YY QKP